

SAFETY

FOR YOUR SAFETY AND SAFETY OF OTHERS!

Safety precautions should be followed at all times when operating this equipment. Failure to read and understand the Safety Messages and Operating Instructions could result in injury to yourself and others.

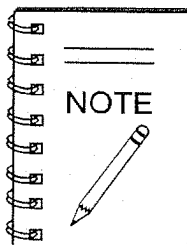

This manual has been developed to provide complete instructions for the safe and efficient operation of this equipment.

Before using this equipment ensure that the operating individual has read and understood all instructions in this manual.

SAFETY MESSAGE ALERT SYMBOLS

The three Safety Messages shown below will inform you about potential hazards that could injure you or others. The Safety Messages specifically address the level of exposure to the operator, and are preceded by one of three words: **DANGER**, **WARNING**, or **CAUTION**.

! DANGER

You **WILL** be **KILLED** or **SERIOUSLY INJURED** if you **DO NOT** follow these directions.

! WARNING

You **CAN** be **KILLED** or **SERIOUSLY INJURED** if you **DO NOT** follow these directions.

! CAUTION

You **CAN** be **INJURED** if you **DO NOT** follow these directions.

HAZARD SYMBOLS

Potential hazards associated with the operation of this equipment will be referenced with Hazard Symbols which appear throughout this manual, and will be referenced in conjunction with Safety Message Alert Symbols.

! WARNING — Respiratory Hazards



ALWAYS wear approved respiratory protection when required.

! CAUTION — Rotating Parts Hazards



NEVER operate equipment with covers or guards removed. Keep fingers, hands, hair and clothing away from all moving parts to prevent injury.

! CAUTION — Accidental Starting Hazards



ALWAYS place the equipment ON/OFF switch in the OFF position when the equipment is not in use.

! CAUTION — Eye and Hearing Hazards



ALWAYS wear approved eye and hearing protection.

! CAUTION — Equipment Damage Hazards

Other important messages are provided throughout this manual to help prevent damage to your equipment, other property, or the surrounding environment.

RULES AND REGULATIONS

WARNING — Read This Manual

Failure to follow instructions in this manual may lead to serious injury or even **DEATH!** This equipment is to be operated by trained and qualified personnel only! This equipment is for industrial use only.

GENERAL SAFETY

- **DO NOT** operate or service this equipment before reading this entire manual. 
- This equipment should not be operated by persons under 18 years of age.
- **NEVER** operate this equipment without proper protective clothing, shatterproof glasses, steel-toed boots and other protective devices required by the job.



- **NEVER** operate this equipment when not feeling well due to fatigue, illness or when under medication. 
- **NEVER** operate this equipment under the influence of drugs or alcohol.



- **NEVER** use accessories or attachments that are not recommended by Multiquip for this equipment. Damage to the equipment and/or injury to user may result.
- Manufacturer does not assume responsibility for any accident due to equipment modifications. Unauthorized equipment modification will void all warranties.
- Whenever necessary, replace nameplate, operation and safety decals when they become difficult to read.
- **ALWAYS** check the equipment for loosened threads or bolts before starting.
- **MAINTAIN** equipment in a safe operating condition at all times.
- **KEEP** bystanders, children, and visitors away while operating the equipment. Distractions can cause loss of control.

- **DO NOT** wear loose clothing or jewelry. Contain long hair. Keep hair, clothing, and gloves away from moving parts. Rotating parts can cause injury if contacted.
- **ALWAYS** keep work area clean and free of foreign matter and debris. Also keep work area well lit.

- **NEVER** operate the equipment in an explosive atmosphere or near combustible materials. An explosion or fire could result causing severe **bodily harm or even death.** 

- **DO NOT** overreach. Keep proper footing and balance at all times.

- **NEVER** leave the equipment unattended. When not in use, before servicing, and when changing accessories, always unplug the equipment from the power source.

- **USE** this equipment for its intended purpose only.

- **KEEP** equipment clean for better and safer performance. Keep handles dry, clean, and free from oil and grease.

- **INSPECT** the equipment after each use. Replace any damaged or worn parts immediately. Do not use equipment if defective.

- If a malfunction occurs, immediately unplug the equipment from the power source and correct the problem. If problem cannot be corrected, contact the nearest MQ service center.

- **ALWAYS** store the equipment in a clean, dry location out of the reach of children.

EMERGENCIES

- **ALWAYS** know the location of the nearest **fire extinguisher.** 

- **ALWAYS** know the location of the nearest **first aid kit.** 

- In emergencies, **always** know the location of the nearest phone or **keep a phone on the job site.** Also know the phone numbers of the nearest **ambulance, doctor** and **fire department.** This information will be invaluable in case of emergency.

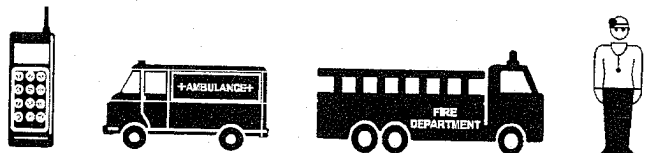

RULES AND REGULATIONS









ELECTRICAL SAFETY

- **ALWAYS** test the **POWER** switch on the equipment before operating. The purpose of this switch is to shut down the power.
- **NEVER** use an extension cord that is frayed or damaged where the insulation has been cut.
- **NEVER** carry the equipment by its power cord or disconnect it by yanking the cord from the power outlet.
- **ALWAYS** make certain that the proper extension cord has been selected for the job. See Extension Cord Gauge Selection Table.
- **NEVER** allow power cord to *lay in water*.
- **NEVER** *stand in water* while operating the equipment.
- When connecting the unit to a power receptacle, make sure the receptacle circuit is connected to either a GFCI receptacle or a receptacle protected by a 20 amp circuit breaker.
- When plugging the unit into a power receptacle, check the nameplate for the correct operating voltage. Operating the rebar bender at the wrong voltage will damage the electrical components. **ALWAYS** read the nameplate before applying power.
- This unit is equipped with a 3-prong male power plug. **DO NOT** use a 2-prong adapter when plugging into a wall outlet. This will defeat the purpose of the ground circuit. If the plug does not fit into the receptacle, contact a qualified electrician to install a 3-conductor wall receptacle (outlet).
- Avoid body contact with grounded surfaces such as pipes, radiators, ranges and refrigerators. There is an increased risk of electrical shock if your body is grounded.
- **DO NOT** expose the hydraulic power unit to rain or wet conditions. Water entering the power unit will increase the risk of electrical shock.
- When operating the unit outdoors, be sure to use the appropriate outdoor extension cord. This type of extension cord reduces the risk of electrical shock.
- **ALWAYS** remove the AC power cord from the power source before performing any service or maintenance on the unit. This preventative safety measure reduces the possibility of accidental starting.
- When operating near an arc welder, it is important the both the unit and the welding equipment be connected to the same earth ground. If they are not, server damage to the unit, particularly to the power cord could occur. Personal injury may also occur.

Extension Cord Gauge Selection										
Ampere Rating Range	Volts	Length of Cord in Feet								
	115V	25 Ft.	50 Ft.	100 Ft.	150 Ft.	200 Ft.	250 Ft.	300 Ft.	400 Ft.	500 Ft.
	230V	50 Ft.	100 Ft.	200 Ft.	300 Ft.	400 Ft.	500 Ft.	600 Ft.	800 Ft.	1000 Ft.
0 - 2		18	18	18	16	16	14	14	12	12
2 - 3		18	18	16	14	14	12	12	10	10
3 - 4		18	18	16	14	12	12	10	10	8
4 - 5		18	18	14	12	12	10	10	8	8
5 - 6		18	16	14	12	10	10	8	8	6
6 - 8		18	16	12	10	10	8	6	6	6
8 - 10		18	14	12	10	8	8	6	6	4
10 - 12		16	14	10	8	8	6	6	4	4
12 - 14		16	12	10	8	6	6	6	4	2
14 - 16		16	12	10	8	6	6	4	4	2
16 - 18		14	12	8	8	6	4	4	2	2
18 - 20		14	12	8	6	6	4	4	2	2

SPECIFICATIONS

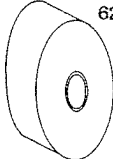
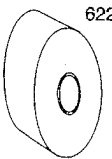
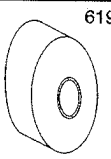
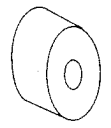
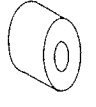
TABLE 1. SPECIFICATIONS		
Model	MB25A	
Capacity	Ø6(1/4") - Ø25(1"), No.2 - No.8	
Range of Bends	0° - 180°	
Motor	Single Phase, 115 V, 60 Hz, 13A	
Standard Equipment	Roller - 5	Allen Wrench - 2
	Collar - 6	Open-End Wrench - 1
	Waterproof Cover - 1	Screwdriver - 1
	Tool Box - 1	Foot Switch - 1

TABLE 2. SIZE OF ROLLERS AND COLLARS						
REBAR DIAMETER	No. 8 1-inch (25.4mm)	No. 7 7/8-inch (22.2mm)	No. 6 3/4-inch (19.0mm)	No. 5 5/8-inch (15.9mm)	No. 4 1/2-inch (12.7mm)	No. 3 3/8-inch (9.52mm)
ROLLER DIAMETER	625  DIA. 2.54" (64.5MM)	622  DIA. 3.62" (92MM)	619  DIA. 4.67" (119MM)	616  DIA. 5.6" (142MM)	613  DIA. 6.61" (168MM)	613  DIA. 6.61" (168MM)
COLLAR DIAMETER	625  DIA. 6.00" (152MM)	622  DIA. 5.25" (133MM)	619  DIA. 4.50" (114MM)	616  DIA. 3.75" (95MM)	613  DIA. 3.00" (76MM)	610  DIA. 2.25" (57MM)

NOTE: Roller No. 625 and Collar No. 625 are factory installed on the bender.

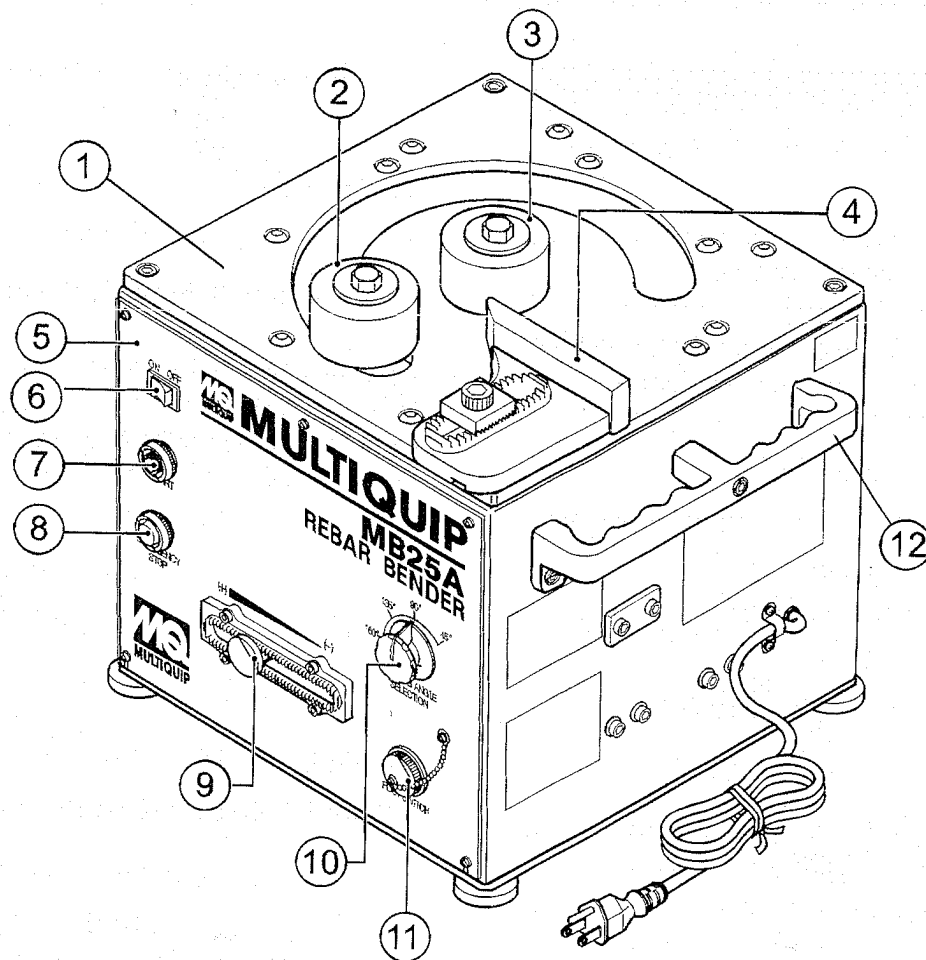

Figure 1. MB25A Components

Figure 1 shows the components of the MB25A Rebar Bender. These components are described below.

1. **Table** - Holds the roller, collar, stopper and the rebar to be bended.
2. **Roller** - Works in combination with the collar depending on the diameter of the rebar to bend.
3. **Collar** - Works in combination with the roller depending on the diameter of the rebar to bend.
4. **Stopper** - Holds the rebar in place when bending.
5. **Panel A** - Holds the different controls for the rebar bender.
6. **Power Switch** - Turns the power of the rebar bender on or off.
7. **Start Switch** - Starts the bending process.
8. **Emergency Stop Switch** - Stops the rebar bending and moves the roller back to the starting position.
9. **Angle Adjusting Knob** - Used to "fine tune" the angle after trial bends of a few pieces of rebar.
10. **Angle Select Dial** - Sets the angle that the rebar is going to be bent.
11. **Connector (for foot switch)** - Connects to the foot switch to start the machine with a push of the pedal.
12. **Handle** - Used to lift the rebar bender.

SELECTION AND INSTALLATION OF ROLLER AND COLLAR

WARNING

Keep fingers from the bending area. Moving parts can cause serious injury.

Do not drop anything into the machine from the bending area as this may damage the machine.

1. Select the roller and corresponding collar to match the diameter of the rebar to be bent. See Table 2 for the different combinations.
2. Apply multi-purpose grease to the roller.
3. Install the collar and the roller as shown in Figure 2.

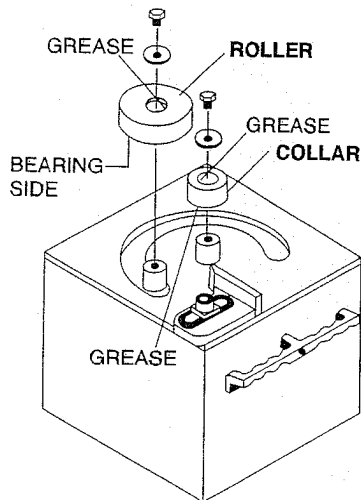

Figure 2. Roller and Collar Installation

4. When using a roller with a bearing, bearing must face downward.
5. When using a collar with a bearing, bearing must face downward.
6. To prevent the roller and the collar from coming off, attach the washer securely with the bolt.
7. Position the stopper so that rebar to be bent is parallel to the front of the stopper and tighten the rebar securely in place. If the rebar is not parallel to the front, the bending angle will be incorrect. See Figure 3.

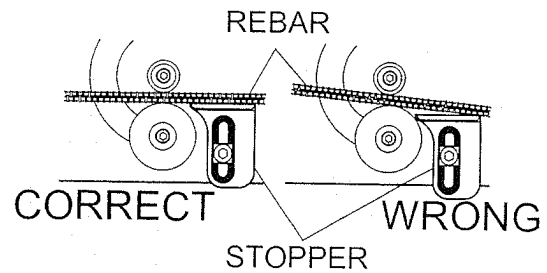

Figure 3. Stopper Position

8. Rotate the Angle Select Dial to the desired angle that the rebar is to be bent (Figure 4). If the selected angle cannot be obtained by the Angle Select Dial, "fine tune" the angle by using the Angle Adjusting Knob (Figure 5).

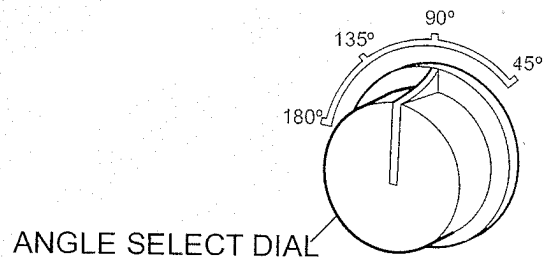

Figure 4. Selecting the Bending Angle

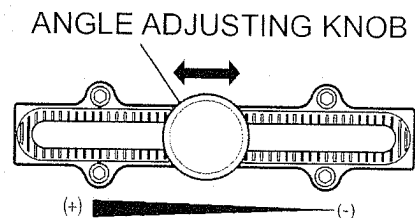

Figure 5. Fine Tuning the Bending Angle

9. Plug the power cord into a proper single-phase power source. Make sure that the rebar bender is properly grounded.
10. Turn the power switch on.
11. Hold the rebar firmly and press the Start Switch. This will engage the clutch and the roller to bend the rebar.
12. After the rebar is bent to the desired angle, the roller will automatically spring back to the starting position.

OPERATION

USING THE ANGLE ADJUSTING KNOB

Depending on the diameter of the rebar and its tensile strength, it may be necessary to "fine tune" the angle using the Angle Adjusting Knob after trial bends of a few pieces of rebar.

1. The Angle Adjusting Knob is automatically locked when released. Unlock the knob by pulling it hard and sliding the knob to the right or left to adjust the angle.
2. When the desired angle is selected, release the knob. The knob will now be automatically locked.

USING THE FOOT SWITCH

Instead of the Start Switch, the Foot Switch can be used to start the bending process. See Figure 6.

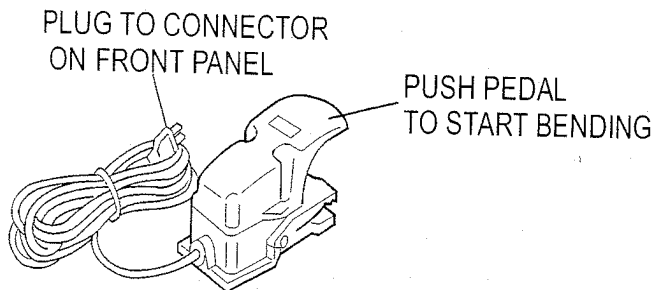
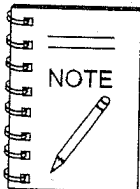

Figure 6. Starting with the Foot Switch

1. Insert the plug of the foot switch to the Foot Switch Connector on the front panel of the rebar bender.
2. Press the pedal on the foot switch to start bending.
3. When the bending angle is achieved, the roller will automatically spring back to the start position.



It is not necessary to press the pedal continuously while bending. Once the pedal is pressed bending will start and pedal can be released.

EMERGENCY STOP SWITCH

1. To stop the rebar bender immediately in case anything goes wrong in the bending process, press the Emergency Stop Button (Figure 7). The roller on the rebar bender will immediately stop and return to the start position.

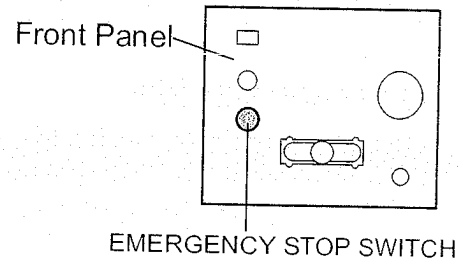

Figure 7. Emergency Stop Switch

WARNING

The roller goes back to start position very quickly after bending because of the spring mechanism. Keep away from the machine until the roller is completely back in the start position to prevent any injury.

DANGER

During operation of this rebar bender, there exists the possibility of **electrocution, electrical shock or burn**, which can cause **severe bodily harm** or even **DEATH!**



To avoid these hazards:

NEVER use damaged or worn cables when plugging the rebar bender into an AC power receptacle.

NEVER grab or touch a live power cord with wet hands.

NEVER stand in water and touch a live power cord.

